

Han® industrial connectors with degree of protection IP 65 / IP 67 represent the worldwide standard for safe installation, quick commissioning and easy servicing of machines and plants.

The use of Han® connectors enables efficient and cost-effective modular structures of machines and plants.

The outstanding properties of Han® connectors are reflected by their versatility, application bandwidth and ruggedness. The advantages of the Han® connector family that users know from installation tasks are also available for direct device connections. The Han® connectors support the installation of automation systems in control cabinets and of IP 65 / IP 67 distributed devices using identical connectors.

Key user benefits: Investment and operational security.

Application profile:

CONNECTION TYPE		ENVIRONMENT		APPLICATION						
Board to Board	Cable/Wire to Board	IP 20	IP 65 / IP 67	Data	Signal	Power	high performance			
							Data transfer rate	Shielding	Number of contacts, contact density	Voltage, working current
<input type="checkbox"/>	<input type="checkbox"/>	<input type="checkbox"/>	<input type="checkbox"/>	<input type="checkbox"/>	<input type="checkbox"/>	<input type="checkbox"/>	<input type="checkbox"/>	<input type="checkbox"/>	<input type="checkbox"/>	<input type="checkbox"/>
Cable termination			PCB termination			Application standard				
Han-Quick Lock®    IDC    Crimp			THT    SMC    SMT							
						ECOFAST				
Screw    Cage clamp    Axial screw			Press-in			Housing integration				
						separate housing		integrated housing		
<input type="checkbox"/>			<input type="checkbox"/>			<input type="checkbox"/>		<input type="checkbox"/>		



Han® connectors with degree of protection IP 65 / IP 67 are established as the worldwide standard for industrial connectors. This standard connector can also be used directly as appliance connector.

The rugged housings are equipped with secure interlock mechanisms that protect the contact inserts from external negative influences such as dust, dampness and mechanical stress. On the appliance side, the connector contacts are routed in the bulkhead mount module, soldered directly onto the PCB and are aligned precisely to the bulkhead frame. This results in appliance connections that are resistant to any environmental stress.

The Han® appliance connectors offer comprehensive solutions based on connector inserts for data, signal and power lines up to 32 A per contact. The Han® 3A housing can be equipped for

communication applications with copper-bound RJ45 modules, 4-pole (Cat. 5) and 8-pole (Cat. 6) and optical LC modules.

The power contact inserts are available for the Han® 3A, Han® Compact and Han® B housing variants. The cables can be wired to the contact inserts by way of crimp, screw or cage clamp terminals, or using the patented Quick-Lock® quick connection technology for on-site assembly.

HARTING highlights its Han® 3A appliance connector series with versatile hybrid contact inserts for wiring data and power lines using a single connector and cable. This functionality results in a reduction of insertion points and cabling by more than 50%.

Han® connectors with high degree of protection can be used for wiring appliances, terminal boxes and control cabinets.



## Han® APPLIANCE CONNECTORS:

The PCB-Adapter of HARTING can be used to convert Han® industrial connectors into fully-fledged PCB connectors. The modular PCB adapters enable the implementation of various Han® contact inserts.

The PCB Adapter concept:

- The PCB adapter is processed as component in a standard soldering process and is a fixed part of the PCB.
- The contact insert of the Han® industrial connector is simply plugged in after the soldering process has been completed.
- The bulkhead mount housing with the bracket interlock is mounted to the appliance housing.

This modularity guarantees the availability of a wide range of contact inserts and connector housings for the assembly of a multitude of rugged IP 65 / IP 67 appliance connectors for data, signal and power lines.

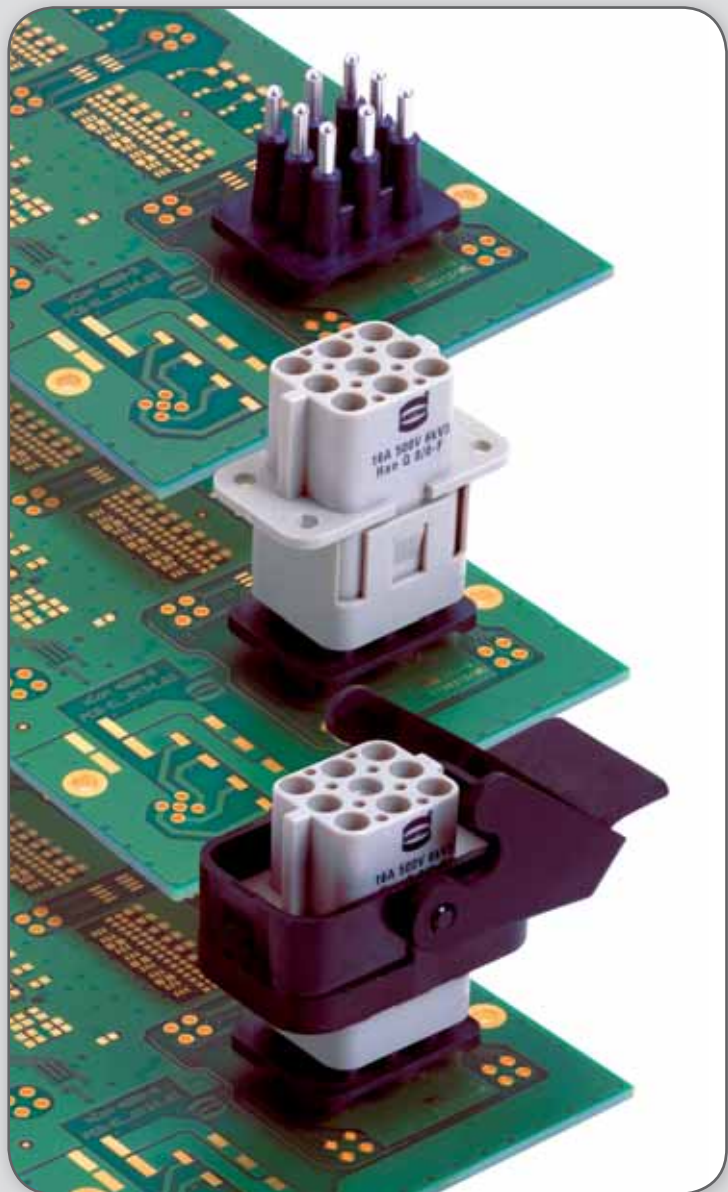

## SCALABLE HYBRID APPLIANCE CONNECTION USING Han® CONNECTORS:

The hybrid appliance connector series enable the cost-effective combination of Fieldbus/Ethernet communication and power supply lines in a single cable and connector.

The contact insert combination for communication and for the power supply to the appliance is soldered directly to the PCB. The bulkhead mount housing can be adapted directly to the housing shape, or be mounted as separate unit to the appliance housing. HARTING offers cable solutions for smaller batches which can be used to connect the contact insert to the PCB.

Key user benefits: A tailored appliance connection is always available for small- and large-scale appliance series.





Han® 3A RJ45 device side

## Advantages

- Simple mounting
- RJ45 plug-compatible
- Different versions cover all applications
- Coding (4 variants) possible

## Technical characteristics

Number of ports	2 / 1x Han® 3A RJ45 (IP 65 / IP 67)
Copper / termination	1x RJ45 (Twisted Pair) (IP 20)
Transmission performance	Category 5 / Class D up to 100 MHz acc. to ISO/IEC 11 801:2002, EN 50 173-1
Transmission rate	10/100/1000 Mbit/s
Shielding	fully shielded, 360° shielding contact
Mounting	screw-on type on steel plate walls
Degree of protection	IP 65 / IP 67
Mating cycles	min. 500
Temperature range	- 40 °C up to + 70 °C
Housing material	
Plastic version	Polycarbonate, black, UL 94-V0
Metal version	Zinc die-cast, powder coating, grey

Identification	Part No.	Drawing	Dimensions in mm
----------------	----------	---------	------------------

### Housing bulkhead mounting

- Plastic version
- Metal version Standard
- Metal version M



- with fixed cover and with seal
- Metal version Standard



### Adapter

- for fixing of RJ45 female with fixing clip
- without fixing clip

### RJ45 Buchsen Cat. 5

- Solder variant SMD, 90° angled

- Solder variant overmolded, 90° angled

09 20 003 0327  
09 20 003 0301  
09 37 003 0301

09 20 003 0306

09 45 515 0020  
09 45 515 0022

09 45 551 1100<sup>1)</sup>  
09 45 551 1110<sup>2)</sup>

09 45 551 1102<sup>1)</sup>

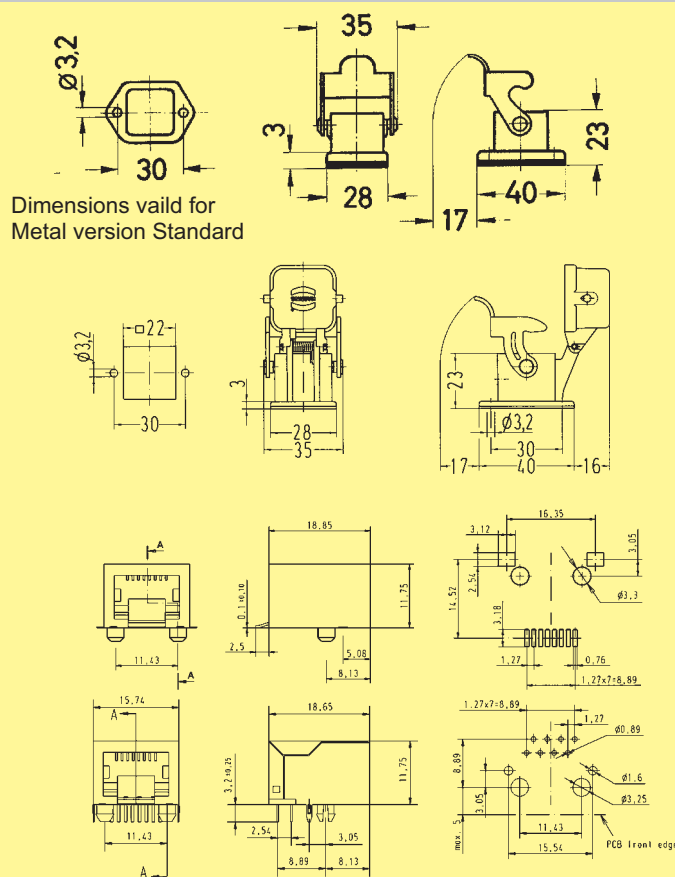

<sup>1)</sup> Packaging: Blister à 120 pieces  
<sup>2)</sup> Packaging: Tape & Reel à 130 pieces



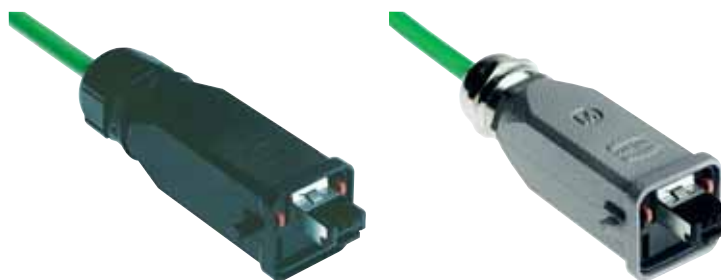

## Han® 3A connector RJ45, 4-poles

### Advantages

- RJ45 Ethernet-Data connector suitable for industry
- Tool-less field-assembly with *HARAX*® rapid termination in IDC technology
- Category of transmission Cat. 5
- Compact design and very robust housing
- Suitable for termination of solid and stranded cables
- Up to 10 x reconductable
- PROFINET compatible
- Min. 500 mating cycles

### Technical characteristics

Connector type	Han® 3A Connector RJ45 acc. to IEC 61076-3-106 variant 5
Number of contacts	4
Transmission performance	Category 5 / Class D up to 100 MHz acc. to ISO/IEC 11801:2002, EN 50173-1
Transmission rate	10/100 Mbit/s
Shielding	fully shielded, 360° shielding contact
Cable termination	tool-less with IDC contacts
Cable diameter	stranded AWG 24/7 - AWG 22/7 solid AWG 23/1 - AWG 22/1
Cable outer diameter	6.0 mm – 9.0 mm
Degree of protection	IP 65/67
Temperature range	– 40 °C up to + 70 °C
Housing material	Plastic version Polycarbonate, UL 94-V0, black Metal versions Standard Zinc die-cast, powder coating grey M-version Zinc die-cast, powder coating black

Identification	Part No.	Drawing	Dimensions in mm
----------------	----------	---------	------------------

Han® 3A connector set RJ45, 4-poles  
incl. housing, cable gland  
and instruction manual

Plastic version	straight	09 45 125 1100
	angled	09 45 125 1104
Metal version Standard	straight	09 45 115 1100
	angled	09 45 115 1104
Metal version M	straight	09 45 115 1102
	angled	09 45 115 1106
Coding pin set		09 45 820 0000

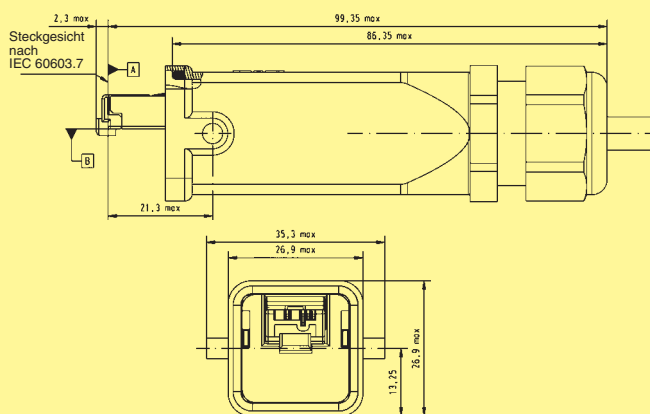

Dimensions valid for plastic version, straight



## Han® 3A connector set RJ45, 8-poles

### Advantages

- RJ45 Ethernet-Data connector suitable for industry
- Field-assembly with mounting tool
- Category of transmission Cat. 6
- Compact design and very robust housing
- Min. 500 mating cycles

#### Reference note:

For cat. 6 patch cords it is recommended to use 1 connector with a white wire manager and one with a blue cable manager, in order to optimise the crosstalk between different signal pairs.

Further informations see also page 01.06.

### Technical characteristics

Connector type	Han® 3A Connector RJ45
Number of contacts	8
Transmission performance	Category 6 / Class E up to 250 MHz acc. to ISO/IEC 11 801:2002, EN 50 173-1
Transmission rate	10/100/1000 Mbit/s
Shielding	fully shielded, 360° shielding contact
Cable termination	with piercing contacts
Cable diameter	AWG 27/7 - AWG 24/7, stranded
Cable outer diameter	6.0 mm – 8.0 mm
Degree of protection	IP 65 / IP 67
Temperature range	– 40 °C up to + 70 °C
Housing material	
Plastic version	Polycarbonate, UL 94-V0, black
Metal versions	
Standard	Zinc die-cast, powder coating grey
M-version	Zinc die-cast, powder coating black

Identification	Part No.	Drawing	Dimensions in mm	
Han® 3A connector set RJ45, 8-poles incl. housing, cable gland and instruction manual				
Plastic version	Wire manager white		Mating face acc. to IEC 60 603-7  Dimensions vaild for metal version Standard	
	Wire manager blue			09 45 125 1500
Metal version Standard	Wire manager white			09 45 115 1500
	Wire manager blue			09 45 115 1510
Metal version M	Wire manager white			09 45 115 1502
	Wire manager blue			09 45 115 1512
Coding pin set		09 45 820 0000		



## Han® 3A 2x LC duplex

### Advantages

- Compact, space-saving Design
- Just one LWL modul for high mechanical load
- High packing density
- A & B parts identification according to TIA 568 standard

### Technical characteristics

Degree of protection	IP 65 / IP 67
Temperature range	-40 °C up to +70 °C
Housing material	Zinc die-cast powder coating black

Identification	Part No.	Drawing	Dimensions in mm
----------------	----------	---------	------------------

#### Components device side

Multimode GOF	09 57 467 0001 000
Singlemode GOF	09 57 467 0002 000 projected

#### Connector

Multimode GOF	09 57 407 0001 000
Singlemode GOF	09 57 407 0002 000 projected



## Han® 3A RJ45 Hybride

### Advantages

- RJ45 Ethernet-Data connector suitable for industry with Power contacts for hybride applications
- Field-assembly with mounting tool
- Category of transmission Cat. 5
- Compact design and very robust housing
- Suitable for termination with solid and stranded cables
- Protection against direct contact on cable and device side according to EN 60529

#### Reference note:

For cat. 6 patch cords it is recommended to use 1 connector with a white wire manager and one with a blue cable manager, in order to optimise the crosstalk between different signal pairs.

### Technical characteristics

Degree of protection	IP 65 / IP 67
Mating interface	RJ45, 8-poles acc. to IEC 60 603-7 plus 3x power
Temperature range	- 40 °C up to + 70 °C
Housing material	Zinc die-cast, powder coating black
<b>Data</b>	
Transmission performance	Category 5 / Class D up to 100 MHz acc. to ISO/IEC 11 801:2002, EN 50 173-1
Transmission rate	10/100 Mbit/s
Shielding	fully shielded, 360° shielding contact
Cable diameter stranded	AWG 27/7 - AWG 24/7
<b>Power</b>	
Number of contacts	3 (AC: L1, PE, N / DC: V+, GND, V-)
Working voltage	300 V AC/DC
Working current	12 A @ 70 °C (see current carrying capacity Han D® contacts)
Cable diameter	2.5 mm <sup>2</sup>

Identification	Part No.	Drawing	Dimensions in mm
<b>Components device side</b> incl. 3x Han D® female contacts			
AC version	09 57 368 0500 000		
DC version	09 57 368 0501 000		
<b>Cable side</b> Connector incl. 3x Han D® male contacts			
AC version	09 57 308 0500 000		
DC version	09 57 308 0501 000		
Suitable Hybride cable Cat. 5 coil 500 m	33 57 851 5000 001		Sheath: PVC, black Temperature range: -30 °C ... +80 °C Data: 4 x 2 x AWG 26/7 Power: 3 x AWG 14 (L1-N-PE)



## Han® 3A LC duplex Hybride

### Advantages

- Small form factor (compared to SC and ST®)
- Compact, space-saving Design
- Combined to only one LWL-modul for high mechanical load
- High packing density
- A & B partsidentification according to TIA 568 standard

### Technical characteristics

Degree of protection	IP 65 / IP 67
Temperature range	-40°C up to +70°C
Data	
Mating module	LC duplex (2 fibres)
Cable diameter	6.0 ... 9.0 mm
Power	
Number of contacts	3(AC: L1, PE, N / DC: V+, GND, V-)
Working voltage	300 V AC/DC
Working current	12 A @ 70°C
Number of contacts	3(AC: L1, PE, N / DC: V+, GND, V-)
Housing material	Aluminium die-cast, black

#### Identification

#### Part No.

#### Drawing

#### Dimensions in mm

#### Components device side

Power: 3x Han D® male contacts

Data: Multimode GOF	AC	09 57 568 0500 000 projected
	DC	

Data: Singlemode GOF	AC	09 57 568 0501 000 projected
	DC	

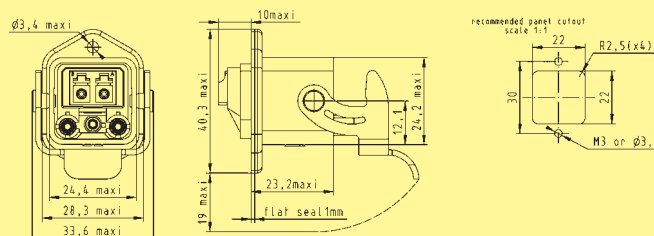

#### Connector

Power: 3x Han D® female contacts

Data: Multimode GOF	AC	09 57 508 0500 000 projected
	DC	

Data: Singlemode GOF	AC	09 57 508 0501 000 projected
	DC	

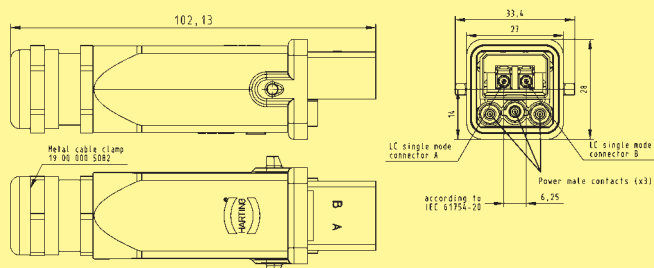





## Han® 3A RJ45, Hybride

### General information

With the RJ Industrial Hybrid connector, HARTING has developed an interface solution that integrates the data lines and the power supply into one connector for hybrid Ethernet networks. The connector's geometry nevertheless maintains a clear separation between the data and the power contacts. This brings a significant reduction in the costs of installation and of field devices suitable for industrial application with hybrid cabling.

The panel feed through is compatible with RJ45 connectors, which means that the standard patch cables for service and test purposes can be used. The data lines are connected at the rear via an RJ45 jack, while the power lines use a cage clamp terminal.

Optional the hybrid interface can be integrated in the device directly, thus preventing the use of rear side data lines.

The four power contacts of the hybrid module have also been designed with HARAX® rapid termination technology, allowing stranded cables of up to 1.5 mm<sup>2</sup> to be connected.

Current carrying capacity „Power contacts“

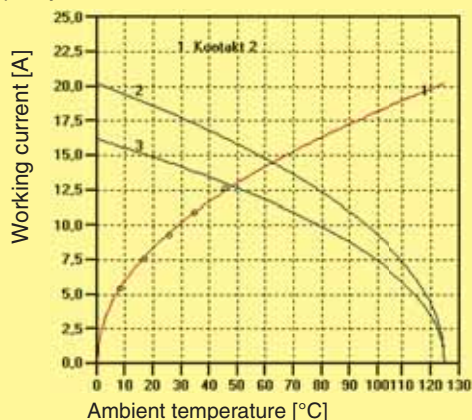

1 Temperature rise  
 2 Derating  
 3 Derating curve at I<sub>max</sub> \* 0,8 (DIN IEC 512)

### Technical characteristics

<b>Connector</b>	
Degree of protection	IP 65 / IP 67
Mating interface	RJ45, 4-poles acc. to IEC 60 603-7 plus 4x power
Temperature range	- 40 °C up to + 70 °C
<b>Housing material</b>	
Plastic version	UL 94-V0, black
Metal version	Zinc die-cast, grey
Mating cycles	min. 500
Mounting	field-assembly

<b>Data</b>	
<b>Transmission performance</b>	
	Category 5 / Class D up to 100 MHz acc. to ISO/IEC 11801:2002, prEN 50 173-1
Transmission rate	10/100 Mbit/s
Shielding	fully shielded, 360° shielding contact
<b>Cable diameter</b>	
stranded	AWG 24/7 - AWG 22/7
solid	AWG 23/1 - AWG 22/1
Cable outer diameter	10.0 mm – 11.0 mm

<b>Power</b>	
Number of contacts	4 for cable diameter 1,5 mm <sup>2</sup> stranded
Working voltage	48 V
Working current	see current carrying capacity

UL approved (E102079)

<b>Panel feed-through</b>	
Mating interface extern:	RJ45 female acc. to IEC 60603-7 plus 4 x power
Mating interface intern:	RJ45 female acc. to IEC 60603-7 4 x power via cable cage clamp 1.5 mm <sup>2</sup>



Han® 3A, Hybride, components device side panel feed-throughs

Identification	Part No.	Drawing	Dimensions in mm
<p>RJ45 female for direct device integration</p> <p>SMD</p> <p>I</p>	09 45 551 1100		<p>pcb layout</p>
<p>Power module with 4 contacts for direct device integration</p> <p>II</p>	09 45 525 0040		<p>recommended PCB power layout (SMD) scale 4:1</p>
<p>Housing bulkhead mounting separate incl. flat seal for direct device integration</p> <p>Plastic version Metal version Standard</p> <p>III</p>	<p>09 45 525 0021 09 45 820 0000</p>	<p>① Han 3A Cover RB 29 00 030 0021 ② 1787 Plastic connector housing 95 00 45 00 16</p>	<p>Dimensions valid for plastic version</p>
<p>panel feed-throughs set incl. housing bulkhead mounting and instruction manual</p> <p>Plastic version Metal version Standard</p> <p>IV</p>	<p>09 45 225 1300 10 12 005 1002</p>		
<p>Protection cover for panel feed-through IP 65 / IP 67</p> <p>Plastic version, black Metal version Standard, grey</p>	<p>09 20 003 5449 09 20 003 5425</p>		



## Han® 3A RJ45, Hybride

Identification	Part No.	Drawing	Dimensions in mm
<b>Connector set</b> Incl. housing and cable gland and instruction manual			
Plastic version	09 45 125 1300		
Metal version	10 12 005 2001		
<b>Protection cover for connector</b> IP 65 / IP 67 without seal			
Plastic version, black	09 20 003 5442		
Metal version Standard, grey	09 20 003 5428		
Metal version M	09 37 003 5402		

Dimensions vaild for plastic version



PROFINET Type B cable, Hybride  
 Industrial Cat. 5 Hybride cable, 4-wire + 4x Power  
 to make up Hybride system cables

## Advantages

- Robust design for industrial environment
- PROFINET-conform
- Additional power supply
- Hybride Cat. 5 cable, 4-wire + 4x Power

## Technical characteristics

Cable construction	Twisted Pair + 4 Power cables, double shielded
Core structure	2 x 2 x AWG 22/7 + 4 x 1.5 mm <sup>2</sup> (conductor 84 x 0.15 mm <sup>2</sup> )
Sheath material	FRNC
Cable outer diameter	10.3 mm
Transmission performance	Category 5 / Class D up to 100 MHz acc. to ISO/IEC 11 801:2002, EN 50 173-1
Transmission rate	10/100 Mbit/s
Shielding	Shielding foil and shielding braid
Temperature range	- 20 °C up to + 70 °C
Standard lengths	10 m / 20 m / 50 m / 100 m
Colour	green
Printing	HARTING specific printing

Identification

Part No.

Drawing

Dimensions in mm

PROFINET Type B cable, Hybride  
 Industrial Cat. 5 Hybride cable,  
 4-wire + 4x Power

10 m ring  
 20 m ring  
 50 m ring  
 100 m ring

09 45 600 0310  
 09 45 600 0330  
 09 45 600 0340  
 09 45 600 0300



## Features

### General Description

The Han-Brid® series allows the connection of a data interface and a power supply in a single space saving connector. This means that it is now possible to provide data transmission and power to devices in a single bus structure. This hybrid connector family includes provision for connection of a max. 50 V, 10 A power supply together with a range of inserts for connection of a variety of data protocols and transmission medias:

- Han-Brid® F.O. for plastic (POF) or for HCS®\* optical fibre
- Han-Brid® Cu for shielded twisted pair.
- Han-Brid® Quintax 3 A for shielded 4 wire bus systems (2 pair STP)
- Han-Brid® RJ45 C for Ethernet application
- Han-Brid® USB / Firewire for fast data transmission

Han-Brid® inserts fit to the standard plastic as well as metal hoods and housings with seal of the Han® 3 A series offering a degree of protection IP 65 according to DIN EN 60 529.

For harsher environments Han® 3 HPR hoods and housings with a degree of protection of IP 68 can be used.

## Power supply

- Han D® male and female with standard crimp contacts
- Rated current 10 A
- Rated voltage 50 V
- Wire gauge 0.14 - 2.5 mm<sup>2</sup>
- Approval 

## Data interfaces

### Han-Brid® F.O.

- Is suitable for all HP Versatile Link (Horizontal Package) transmitters and receivers
- Data rates: Standard 12 Mbit/s, suitable for all common fieldbus systems
- Insert allows integration of HP standard contacts for POF and HCS®\* fibres
- Temperature range                    -40 °C ... +70 °C

### Han-Brid® Cu

- For termination of a shielded twisted pair
- Insert for 2x Han D® male or female contacts
- Connection of the shield by means of shielding plate and fixing clamps
- Connection of the device side can be realized either by a printed circuit board as a modular version or as part of the appliance PCB
- Insert for bulkhead mounted housing or the coupling housing are always equipped with a screening spring

### Bus Terminator

- Active bus terminator in male and female version
- Standard Han® 3 A hoods and housings
- Power supply to the termination network via electrical contacts of Han-Brid®
- Integrated, galvanically separated DC/DC converter 24 V / 5 V

### Han-Brid® Quintax 3 A

- Possibility to terminate shielded 4 wires conductors (2 pair STP)
- Suitable for all 4-wire bus systems
- Suitable for shielded cable conductor diameter 3 – 9.5 mm
- Transmission of shielding separately from the hood's ground
- Connections are carried out acc. to DIN EN 50 173, Cat. 5
- Temperature range                    -40 °C ... +70 °C

### Han-Brid® RJ45 C

- Suitable for standard RJ45 Plug and Jack, shielded version
- Connections provided for conductors acc. to DIN EN 50 173, Cat. 5
- Termination from the device side is carried out via a PCB, two versions are possible: modular version or as part of the appliance PCB
- Assembly with standard tools
- Insert for 2 Han-D® male or female contacts offers the combination with electrical bus connector
- Rated current                            10 A
- Rated voltage                            24 V
- Wire gauge                                0.14 - 2.5 mm<sup>2</sup>

### Han-Brid® USB

- Insert for all Han® 3 A hoods and housings
- Hood with glued sealing
- Simple and low-cost termination via insert of a patch cable
- Strain-relief via cable tie

### Han-Brid® FireWire

- Insert for all Han® 3 A hoods and housings
- Hood with glued sealing
- Simple and low-cost termination via insert of a patch cable
- Strain-relief via cable tie
- Compatible to IEEE 1394

\* HCS® Hard Clad Silica (is registered trade mark of the SpecTran Corporation)

## Overview (Sample: Han-Brid® Cu)

Thermoplastic  
 09 20 003 0320 (light grey)  
 09 20 003 0327 (black)

Metal  
 09 20 003 0301

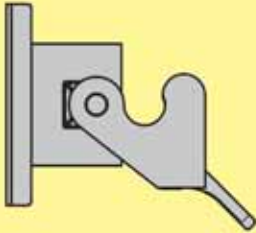

Device side  
 09 12 006 2611  
 09 12 006 2695  
 09 12 006 2694

Cable side  
 09 12 006 3111

Thermoplastic  
 09 20 003 0423 (light grey)  
 09 20 003 0426 (black)  
 19 20 003 0423 (light grey)  
 19 20 003 0427 (black)

Metal  
 09 20 003 1443  
 19 20 003 1443

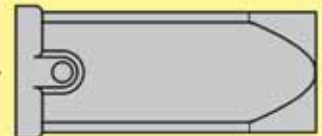
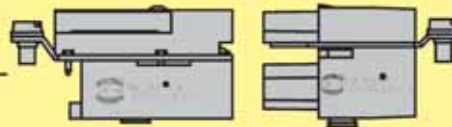

Thermoplastic  
 09 20 003 0720 (light grey)  
 09 20 003 0727 (black)  
 19 20 003 0720 (light grey)  
 19 20 003 0727 (black)

Metal  
 09 20 003 1750  
 19 20 003 1750

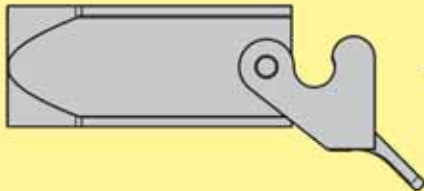

Device side  
 09 12 006 2701  
 09 12 006 2795  
 09 12 006 2794

Cable side  
 09 12 006 3001

Thermoplastic  
 09 20 003 0623 (light grey)  
 09 20 003 0626 (black)  
 19 20 003 0623 (light grey)  
 19 20 003 0627 (black)

Metal  
 09 20 003 1643  
 19 20 003 1643

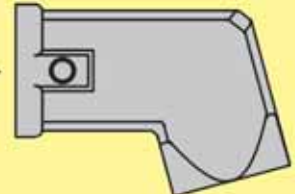
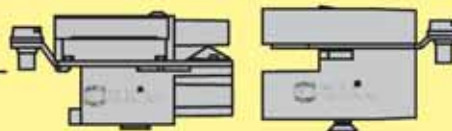

Thermoplastic  
 09 20 003 0220 (light grey)  
 09 20 003 0227 (light grey)  
 19 20 003 0220 (light grey)  
 19 20 003 0227 (black)

Metal  
 09 20 003 1250  
 19 20 003 1250

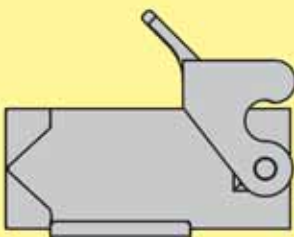

Hybrid field bus connector  
for shielded twisted pair  
+ 4 electrical contacts 10 A  
+ option for PE



Identification	Part number		Drawing	Dimensions in mm
	Male insert (M)	Female insert (F)		

Cable side  
Female insert

Device side  
Male insert

<b>09 12 006 3111</b>	
09 12 006 2611	
Also available as single part	Also available as single part
loaded 09 12 002 2611	unloaded 09 12 004 3011
unloaded 09 12 002 3011	

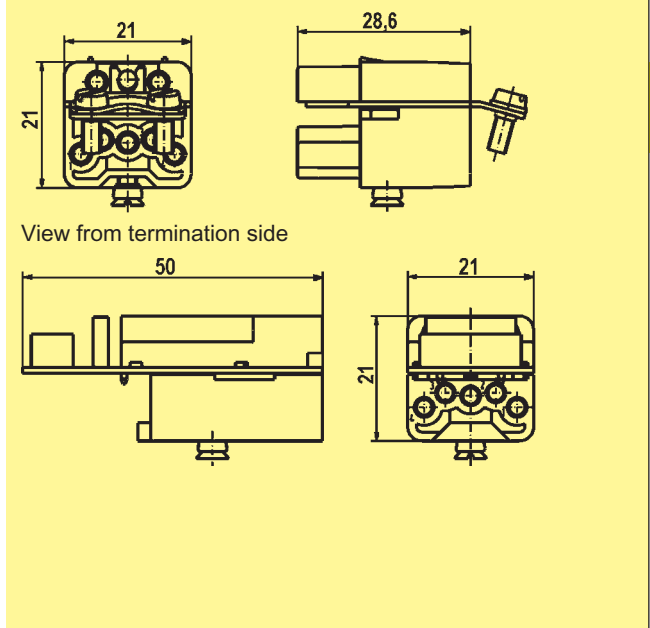



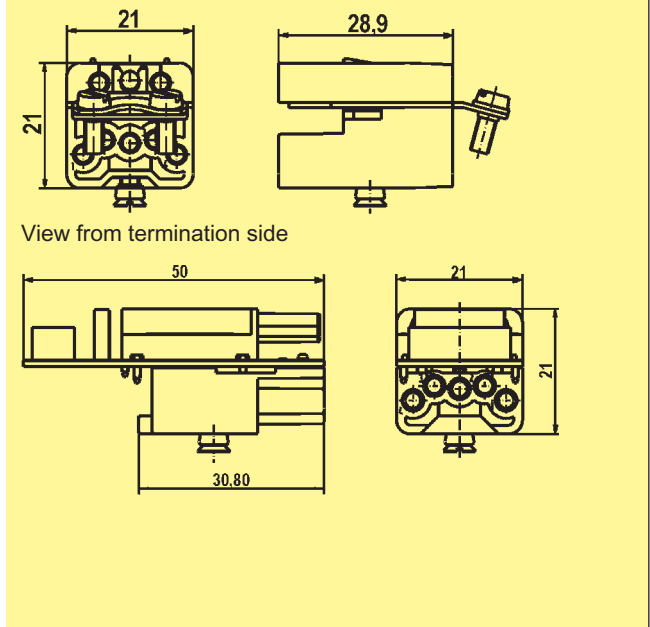

Cable side  
Male insert

Device side  
Female insert

<b>09 12 006 3001</b>	
09 12 006 2701	
Also available as single part	Also available as single part
loaded 09 12 002 2701	unloaded 09 12 004 3101
unloaded 09 12 002 3101	

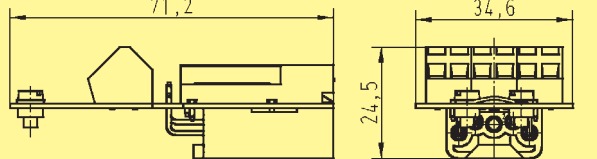
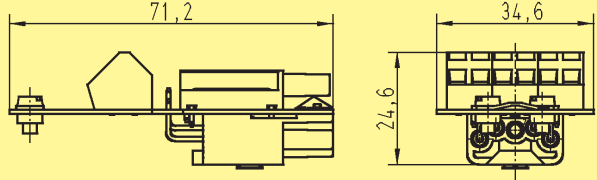

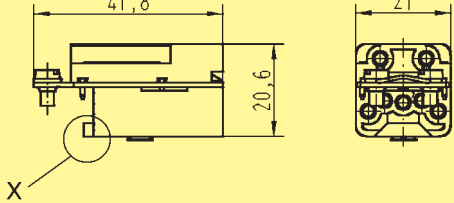
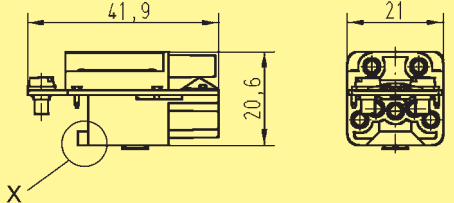
Han

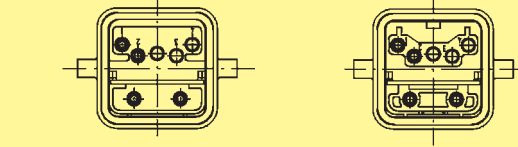
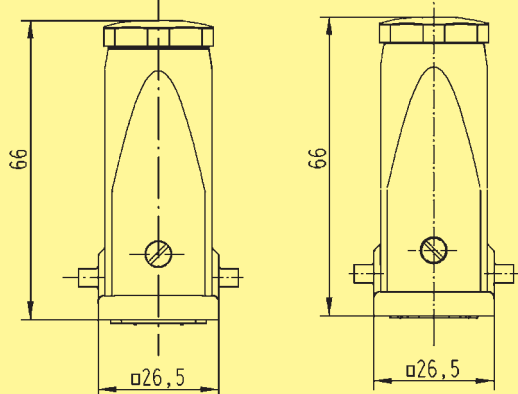
Identification	Part number		Drawing	Dimensions in mm
	Male insert (M)	Female insert (F)		
<p>Panel feed through with cage clamp</p> 	<b>09 12 006 2695</b>			
		<b>09 12 006 2795</b>		
<p>Coupling / Panel feed through</p>  <p>X = Cutting off the fin allows the use in cable to cable housings</p>	<b>09 12 006 2694</b>			
		<b>09 12 006 2794</b>		
<p>Bus terminator</p> <p>Plastic hoods/housings</p>  <p>Hoods/Housings, metal</p> 	<b>09 12 006 2691</b>			
		<b>09 12 006 2791</b>		
	<b>09 12 006 2692</b>			
		<b>09 12 006 2792</b>		

Hybrid field bus connector  
with F.O. transmitter and receiver  
+ 4 electrical contacts 10 A  
+ option for PE



Identification	Part number		Drawing	Dimensions in mm
	Male insert (M)	Female insert (F)		

**Cable side**  
F.O. (m) + Han D® (f)

Also available as single part	Also available as single part
for POF 09 12 004 2711	for POF 09 12 004 3111
for POF crimpless 09 12 004 2713	for POF crimpless 09 12 004 3113
for HCS®* fibre 09 12 004 2716	for HCS®* fibre 09 12 004 3116

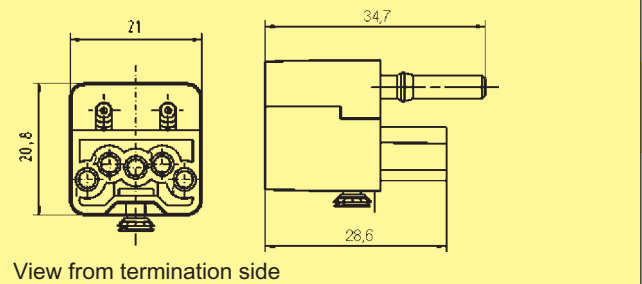

**Device side**  
F.O. (f) + Han D® (m)

for POF 09 12 004 2611	for POF 09 12 004 3011
for POF crimpless 09 12 004 2611	for POF crimpless 09 12 004 3011
for HCS®* fibre 09 12 004 2611	for HCS®* fibre 09 12 004 3011

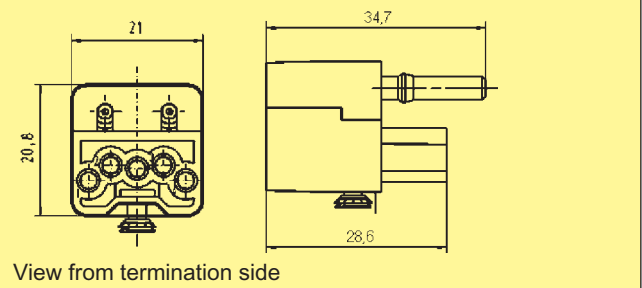

**Cable side**  
F.O. (m) + Han D® (m)

Also available as single part	Also available as single part
for POF 09 12 004 2601	for POF 09 12 004 3001
for POF crimpless <b>09 12 004 2603</b>	for POF crimpless 09 12 004 3003
for HCS®* fibre 09 12 004 2606	for HCS®* fibre <b>09 12 004 3006</b>

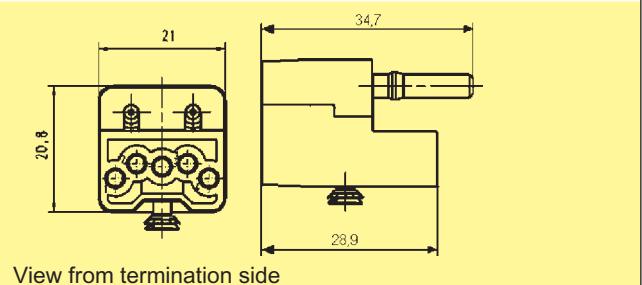

**Device side**  
F.O. (f) + Han D® (f)

for POF 09 12 004 2701	for POF 09 12 004 3101
for POF crimpless 09 12 004 2701	for POF crimpless 09 12 004 3101
for HCS®* fibre 09 12 004 2701	for HCS®* fibre 09 12 004 3101

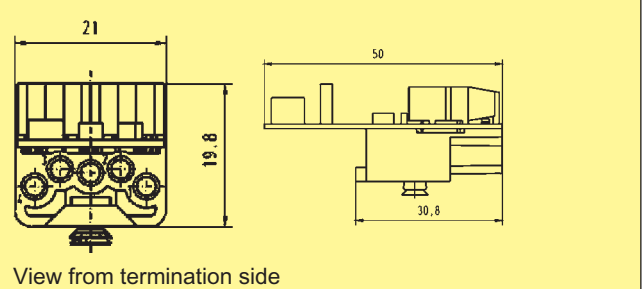

\* HCS®=Hard Clad Silica (is registered trade mark of the SpecTran Corporation)

4 contacts + shielding  
 + 2 power contacts  
 suitable in Han® 3 A metric  
 hoods and housings



Identification	Part number		Drawing	Dimensions in mm
	Male insert (M)	Female insert (F)		
<b>Quintax insert</b> 	<b>09 15 003 3001</b>	<b>09 15 003 3101</b>		
<b>Quintax contacts</b> Zinc alloy Order crimp contacts separately (see page )06.55  Special clamp for cable diameter 3 - 6 and 6 - 9.5 mm included in delivery range	<b>09 15 004 3013</b>	<b>09 15 004 3113</b>		

## Assembly instructions

### Quintax-Z-contact

- Strip cable acc. to drawing 1 and fold the shielding over the cable.
- Crimp Han D® contacts onto the wires.
- Insert Han D® contacts into corresponding cavities of insulator until they are snapped in.
- Fit the insert including the cable into the opened shielded bushing. The coding pin of the shielded bushing has to meet the groove of the insulator.
- Clamp the tilt over the shielding onto the cable by means of the special clamp (small opening for cable diameter of 3 - 6 mm, large opening for cable diameter of 6 - 9.5 mm).
- Check the wiring.
- Close the shielded bushing with the cover and insert it into the corresponding cavity of the Quintax Module as usual.

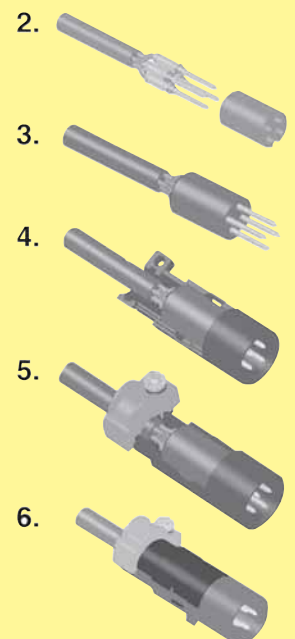
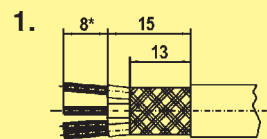





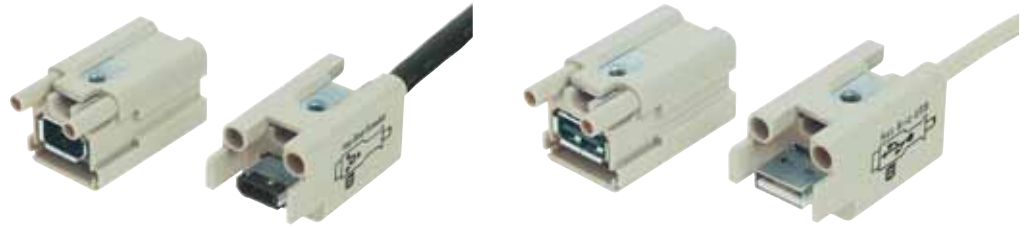

Identification	Part number		Drawing	Dimensions in mm
	Male insert (M)	Female insert (F)		



<b>09 12 001 2794</b>	
	<b>09 12 001 3091</b>

	<b>09 12 001 3091</b>
--	-----------------------

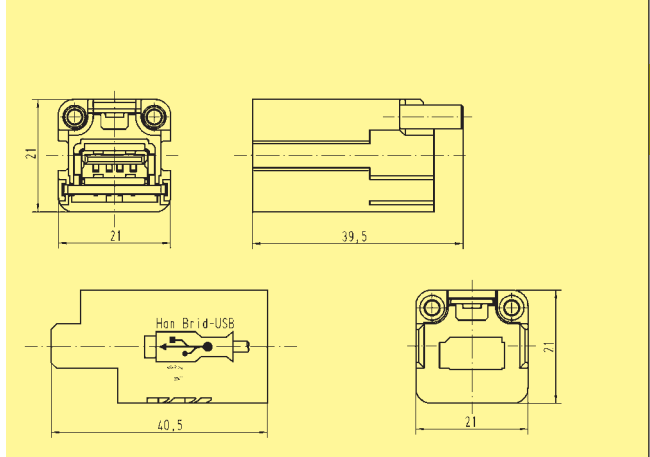

<b>09 12 001 2774</b>	
	<b>09 12 001 3071</b>

	<b>09 12 001 3071</b>
--	-----------------------

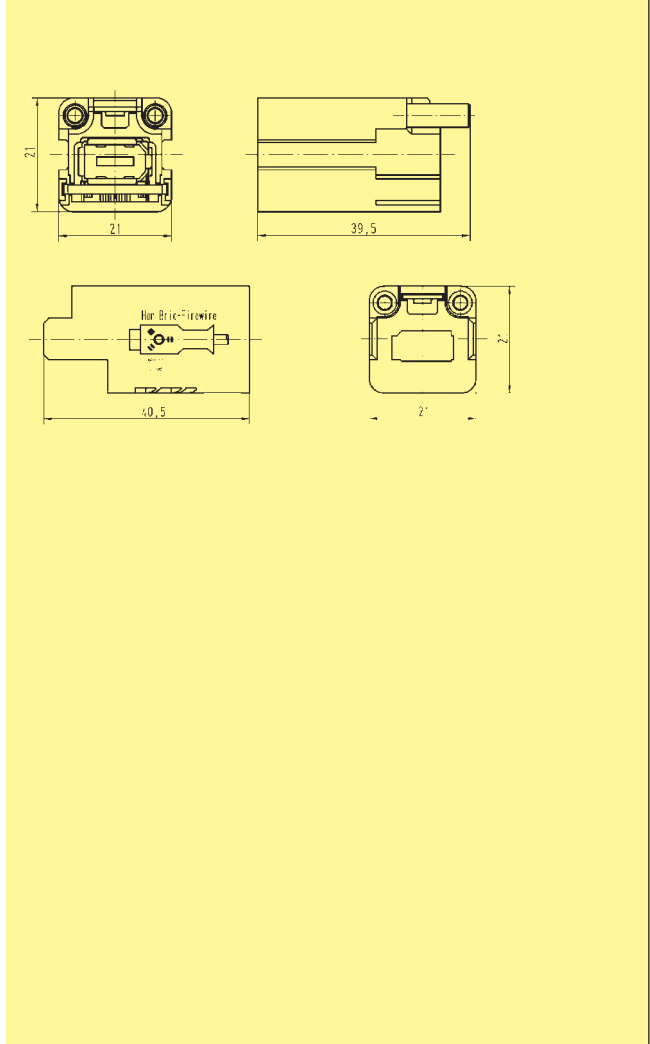

Han



Insert	Part No.		Drawing	Dimensions in mm
	Male insert (M)	Female insert (F)		
Order contacts separately	<b>09 12 005 3001</b>	<b>09 12 005 3101</b>		

<sup>1)</sup> Distance for contact max. 21 mm

PCB-adapter	Part No.		Drawing	Dimensions in mm
with PE contact panel for Han® Q 5/0	<b>09 12 000 9905</b>			

Adapter

PE contact panel

Solder contacts	Part No.		Drawing	Dimensions in mm
	Male contact	Female contact		
to connect the PCB-adapter	<b>09 33 000 6195</b>	<b>09 33 000 6295</b>		

Housing	bulkead mounting	Part No.	Drawing	Dimensions in mm
		<b>09 62 003 0304</b>		

Further informations see HARTING catalogue "Industrial Connectors Han®, chapter Q"

Han

Device side

Cable side

## Features

- ❑ Robust design
- ❑ Suitable for EMC housings
- ❑ Low wiring costs
- ❑ Additional robust and secure PE-connection between housing and PCB

## Technical characteristics

### Approvals



### Inserts

Number of contacts 5

Electrical data acc. to DIN EN 61 984

10 A 230/400 V 4 kV 3

Working current  
 Working voltage conductor – ground  
 Working voltage conductor – conductor  
 Rated impulse voltage  
 Pollution degree

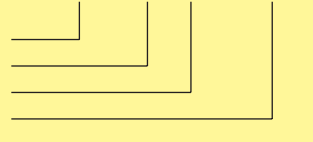

- pollution degree 2 also 10 A 320/500 V 4 kV 2

Working voltage acc. to UL/CSA 400 V

Insulation resistance  $\geq 10^{10} \Omega$   
 Material Polycarbonate  
 Limiting temperatures -40 °C ... +125 °C  
 Flammability acc. to UL 94 V 0  
 Mechanical working life  
 - Mating cycles  $\geq 500$

## Layout of printed circuit boards

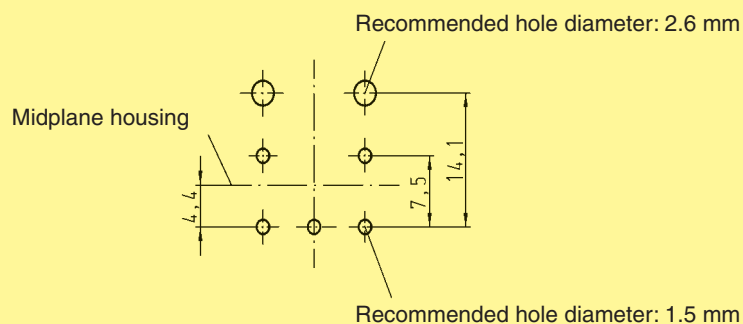

## Assembly situation

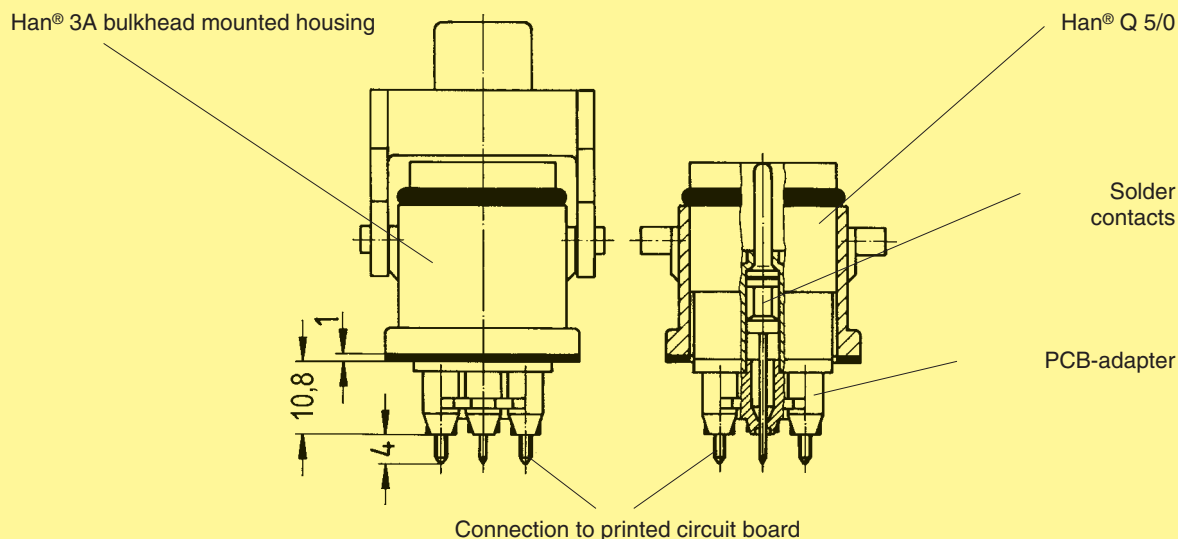



Han

Device side

Cable side

Insert	Part No.		Drawing	Dimensions in mm
	Male insert (M)	Female insert (F)		
Order contacts separately				
	<b>09 12 007 3001</b>	<b>09 12 007 3101</b>		
Coding	<b>09 12 000 9901</b>	<b>09 12 000 9902</b>		

PCB-adapter	Part No.	Drawing	Dimensions in mm
for PCB up to 2.4 mm			
	<b>09 12 000 9908</b>		

Solder contacts	Part No.		Drawing	Dimensions in mm
	Male contact	Female contact		
to connect the PCB-adapter				
	<b>09 15 000 6190</b>	<b>09 15 000 6290</b>		

Housing	bulkead mounting	Part No.	Drawing	Dimensions in mm
		<b>09 20 003 0301</b>	Panel cut out 22 x 22 mm 	

Further informations see HARTING catalogue "Industrial Connectors Han®, chapter Q"

## Features

- ❑ Robust design
- ❑ Suitable for standard and EMC housings
- ❑ Low cost wiring
- ❑ High contact density

## Technical characteristics

### Approvals



### Inserts

Number of contacts 7

Electrical data  
acc. to DIN EN 61 984

**7.5 A 250 V 4 kV 3**

Working current  
Working voltage  
Rated impulse voltage  
Pollution degree

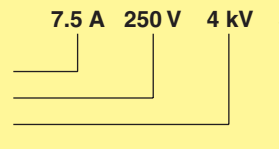

Insulation resistance  $\geq 10^{10} \Omega$   
Material Polycarbonate  
Limiting temperatures - 40 °C ... +125 °C  
Flammability acc. to UL 94 V 0  
Mechanical working life  
- Mating cycles  $\geq 500$

## Layout of printed circuit boards

Midplane housing

Recommended hole diameter: 0.8 mm

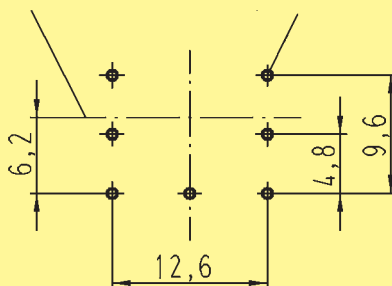

## Assembly situation

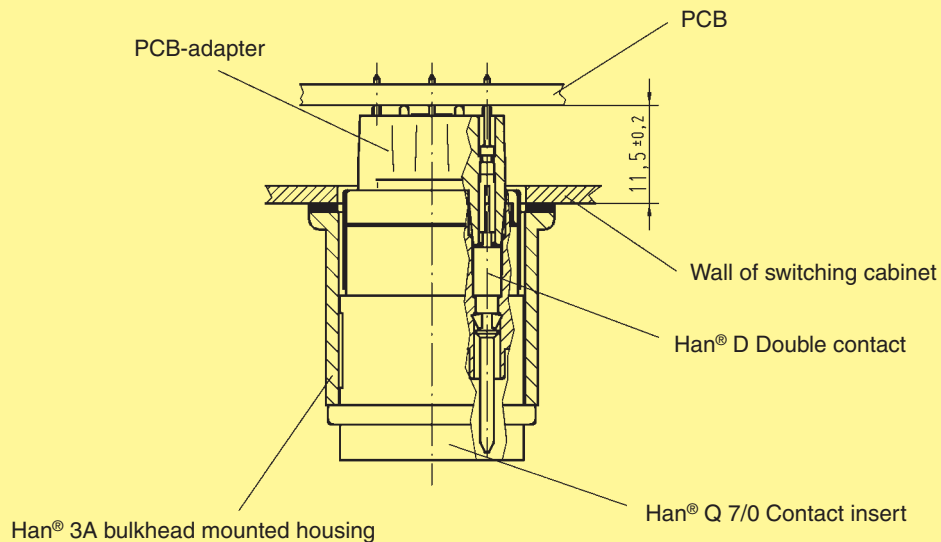

Han

Identification		Part No.	M	Drawing	Dimensions in mm	
Hoods	Hood side-entry	<b>19 20 003 1640</b>	20			
	Hood top-entry	<b>19 20 003 1440</b>	20			
	Protection covers for hoods	<b>09 20 003 5422<sup>1)</sup></b> <b>09 20 003 5421<sup>2)</sup></b>				
Housings	Housings bulkhead mounting	<b>09 20 003 0301</b>				
	with fixed cover	<b>09 20 003 0305<sup>1)</sup></b>				
	without sealing	<b>09 20 003 0306<sup>2)</sup></b>				
	with sealing	<b>09 20 003 0801</b>				
	Housing surface mounting	<b>19 20 003 1250</b>	20			
	1 side-entry	<b>19 20 003 1252</b>	20			
	bottom closed					
Housing screw mounting	<b>19 20 003 1150</b>	20				
Hood cable to cable	<b>19 20 003 1750</b>	20				
Protection covers for housings	<b>09 20 003 5426<sup>1)</sup></b> <b>09 20 003 5425<sup>2)</sup></b>					
for hoods cable to cable	<b>09 20 003 5428<sup>1)</sup></b> <b>09 20 003 5427<sup>2)</sup></b>					

Han

<sup>1)</sup> for mounted male insert    <sup>2)</sup> for mounted female insert

Identification		Part No.	M	Drawing	Dimensions in mm			
Hoods	Hoods side-entry	grey 19 20 003 0620 black 19 20 003 0627	20 20					
	Hoods top-entry	grey 19 20 003 0420 black 19 20 003 0427	20 20					
	Protection covers for hoods	09 20 003 5442 <sup>1)</sup> 09 20 003 5441 <sup>2)</sup>						
Housings	Housings bulkhead mounting	grey 09 20 003 0320 black 09 20 003 0327	— —					
		grey 09 20 003 0820 black 09 20 003 0827	— —					
		Housings surface mounting 1 side-entry	grey 19 20 003 0220 black 19 20 003 0227			20 20		
		Hoods cable to cable	grey 19 20 003 0720 black 19 20 003 0727			20 20		
	Protection covers for housings	A 09 20 003 5407 <sup>1)</sup> <b>09 20 003 5408<sup>2)</sup></b> B 09 20 003 5445 <sup>2)</sup> 09 20 003 5446 <sup>1)</sup> 09 20 003 5447 <sup>2)</sup> C 09 20 003 5448 <sup>1)</sup> 09 20 003 5449 <sup>2)</sup>						

Han

1) for mounted male insert  
2) for mounted female or Han-Brid® insert  
3) for metal housings and cable to cable hoods also

Stock items in bold type



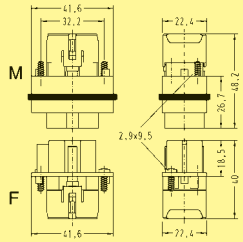
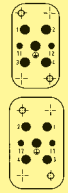

Insert	Part No.		Drawing	Dimensions in mm
	Male insert (M)	Female insert (F)		

Order contacts separately 	<b>09 12 006 3041</b>	<b>09 12 006 3141</b>		Contact arrangement View from termination side 
--	-----------------------	-----------------------	--	--

PCB-adapter	Part No.	Drawing	Dimensions in mm
-------------	----------	---------	------------------

for PCBs up to 2.4 mm 	<b>09 12 006 9901</b>		
--	-----------------------	---	--

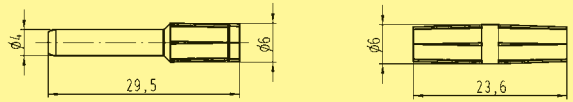
Han® Q 4/2 double contacts	Part No.		Drawing	Dimensions in mm
	Male contact	Female contact		

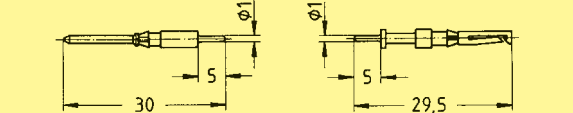
to connect the PCB adapter Power contact 	<b>09 32 000 6180</b>	<b>09 32 000 6280</b>		
Signal contact 	<b>09 15 000 6191</b>	<b>09 15 000 6293</b>		

Housing bulkead mounting	Part No.	Drawing	Dimensions in mm
--------------------------	----------	---------	------------------

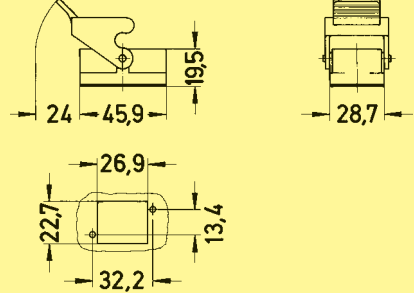
Plastic 	<b>09 12 008 0327</b>	Panel cut out 	
--	-----------------------	--	--

Further informations see HARTING catalogue "Industrial Connectors Han®, chapter Q"

Stock items in bold type

## Features

- ❑ Robust Design
- ❑ Suitable for Han-Compact® hoods and housings
- ❑ Low wiring costs
- ❑ High contact density

## Technical characteristics

Approvals	
Number of contacts	4/2 + PE
<b>Electrical data acc. to DIN EN 61 984</b>	
Power area	30 A 400/690 V 6 kV 2
Rated current	30 A
Rated voltage	
conductor - ground	400 V
conductor - conductor	690 V
Rated impulse voltage	6 kV
Pollution degree	2
Signal area	7.5 A 250 V 4 kV 2
Rated current	7.5 A
Rated voltage	250 V
Rated impulse voltage	4 kV
Pollution degree	2
Insulation resistance	$\geq 10^{10} \Omega$
Material	LCP
Limiting temperatures	-40 °C ... +125 °C
Flammability acc. to UL 94	V 0
Mechanical working life	$\geq 500$ mating cycles

## Layout of printed circuit boards

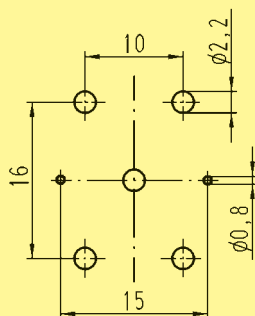

## Assembly situation

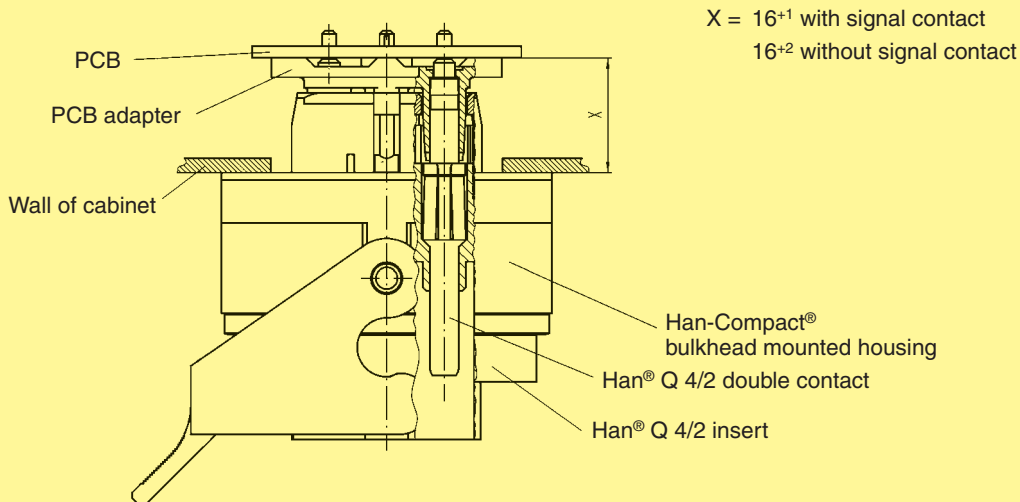

Han



Insert	Part No.		Drawing	Dimensions in mm
	Male insert (M)	Female insert (F)		
Order contacts separately	<b>09 12 008 3001</b>	<b>09 12 008 3101</b>		<p>Contact arrangement View from termination side</p>

PCB-adapter	Part No.	Drawing	Dimensions in mm
for PCBs up to 1.6 mm	<b>09 12 008 9901</b>		

Han® Q 8/0 double contacts to connect the PCB adapter	Part No.		Drawing	Dimensions in mm
	Male contact	Female contact		
	<b>09 33 000 6180</b>	<b>09 33 000 6280</b>		

Housing bulkead mounting	Part No.	Drawing	Dimensions in mm
Plastic	<b>09 12 008 0327</b>	<p>Panel cut out</p>	

Further informations see HARTING catalogue "Industrial Connectors Han®, chapter Q"

Stock items in bold type

## Features

- ❑ Robust Design
- ❑ Suitable for Han-Compact® hoods and housings
- ❑ Low wiring costs
- ❑ High contact density

## Technical characteristics

Approvals	
Number of contacts	8
Electrical data acc. to DIN EN 61 984	16 A 230/400 V 4 kV 2
Rated current	16 A
Rated voltage	
conductor - ground	230 V
conductor - conductor	400 V
Rated impulse voltage	4 kV
Pollution degree	2
Insulation resistance	$\geq 10^{10} \Omega$
Material	LCP
Limiting temperatures	-40 °C ... +125 °C
Flammability acc. to UL 94	V 0
Mechanical working life	$\geq 500$ mating cycles



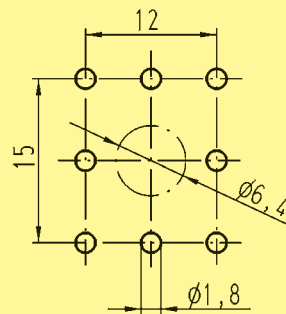

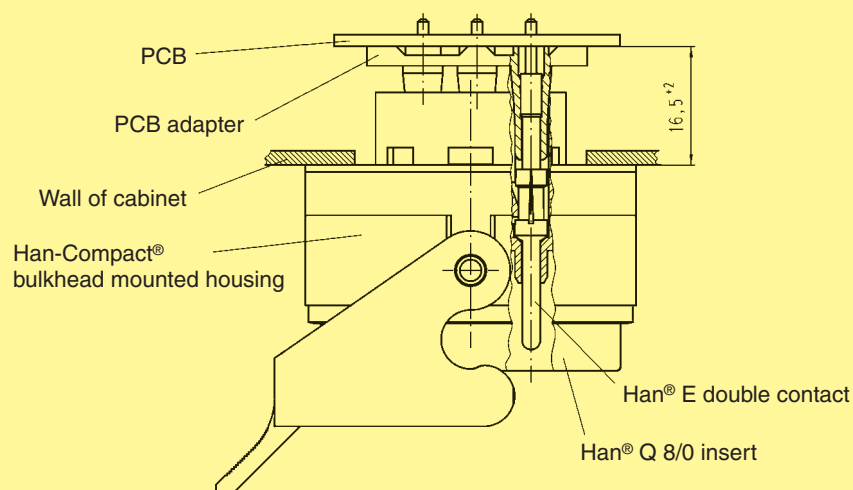

## Layout of printed circuit boards

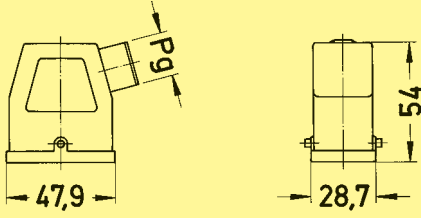

## Assembly situation

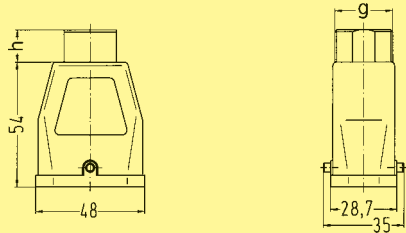

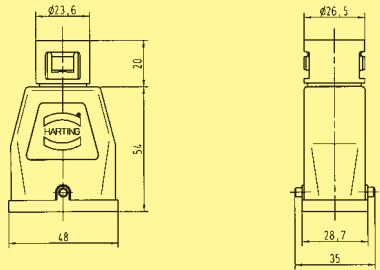
thermoplastic / metal

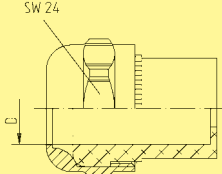
Identification	Part number	Drawing	Dimensions in mm																				
<p>Hoods</p> <p>Hoods</p> <p>Thermoplastic side-entry Cable gland order separately</p> 	<p><b>09 12 008 0527</b></p>	<p>Pg 16</p> 																					
<p>Hoods</p> <p>Thermoplastic top-entry Cable gland order separately</p> 	<p><b>19 12 008 0429</b> <b>09 12 008 0427</b> <b>09 12 008 0429</b></p>	<p>M 25 Pg 16 Pg 21</p>  <table border="1" data-bbox="976 996 1161 1124"> <thead> <tr> <th>h</th> <th>g</th> </tr> </thead> <tbody> <tr> <td>14</td> <td>M 25x1.5</td> </tr> <tr> <td>13</td> <td>Pg 16</td> </tr> <tr> <td>13</td> <td>Pg 21</td> </tr> </tbody> </table>	h	g	14	M 25x1.5	13	Pg 16	13	Pg 21													
h	g																						
14	M 25x1.5																						
13	Pg 16																						
13	Pg 21																						
<p>Hoods</p> <p>Thermoplastic top-entry Cable gland order separately</p> 	<p><b>09 12 008 0428</b></p>	<p>Pg 16</p> 																					
<p>Cable seal</p> <p>Thermoplastic for hoods Thrust bolt and insert</p> 	<p><b>09 00 000 5059</b> <b>19 12 000 5157</b> <b>19 12 000 5158</b> <b>09 00 000 5157</b> <b>09 00 000 5158</b></p>	<p>Pg 16 M 25 M 25 Pg 21 Pg 21</p>  <table border="1" data-bbox="976 1684 1369 1899"> <thead> <tr> <th rowspan="2"></th> <th colspan="2">cable</th> </tr> <tr> <th>min.</th> <th>max.</th> </tr> </thead> <tbody> <tr> <td><b>09 00 000 5059</b></td> <td>11.5 mm</td> <td>15.5 mm</td> </tr> <tr> <td><b>19 12 000 5157</b></td> <td>10.5 mm</td> <td>14 mm</td> </tr> <tr> <td><b>19 12 000 5158</b></td> <td>14 mm</td> <td>17 mm</td> </tr> <tr> <td><b>09 00 000 5157</b></td> <td>14 mm</td> <td>18 mm</td> </tr> <tr> <td><b>09 00 000 5158</b></td> <td>17 mm</td> <td>20.5 mm</td> </tr> </tbody> </table>		cable		min.	max.	<b>09 00 000 5059</b>	11.5 mm	15.5 mm	<b>19 12 000 5157</b>	10.5 mm	14 mm	<b>19 12 000 5158</b>	14 mm	17 mm	<b>09 00 000 5157</b>	14 mm	18 mm	<b>09 00 000 5158</b>	17 mm	20.5 mm	
	cable																						
	min.	max.																					
<b>09 00 000 5059</b>	11.5 mm	15.5 mm																					
<b>19 12 000 5157</b>	10.5 mm	14 mm																					
<b>19 12 000 5158</b>	14 mm	17 mm																					
<b>09 00 000 5157</b>	14 mm	18 mm																					
<b>09 00 000 5158</b>	17 mm	20.5 mm																					

thermoplastic / metal

Identification	Part number	Drawing	Dimensions in mm											
<b>Hoods</b> Hoods Metal side-entry Cable gland order separately	<b>19 12 008 0526</b>													
<b>Hoods</b> Metal side-entry Cable gland order separately	black chromated 19 12 008 0501  black powder coated 19 12 708 0501  matt nickel plated 19 12 008 0502													
<b>Hoods</b> Metal top-entry Cable gland order separately	<b>19 12 008 0426</b>													
<b>Cable seal</b> Metal for hoods Thrust bolt and insert	19 12 000 5057 <b>19 12 000 5058</b>		<table border="1"> <thead> <tr> <th rowspan="2"></th> <th colspan="2">cable</th> </tr> <tr> <th>min.</th> <th>max.</th> </tr> </thead> <tbody> <tr> <td>19 12 000 5057</td> <td>10.5 mm</td> <td>14 mm</td> </tr> <tr> <td>19 12 000 5058</td> <td>14 mm</td> <td>17 mm</td> </tr> </tbody> </table>		cable		min.	max.	19 12 000 5057	10.5 mm	14 mm	19 12 000 5058	14 mm	17 mm
	cable													
	min.	max.												
19 12 000 5057	10.5 mm	14 mm												
19 12 000 5058	14 mm	17 mm												

Identification	Part number		Drawing	Dimensions in mm
	for male insert	for female insert		
<b>Protection covers</b> Thermoplastic for male insert	without sealing 09 12 008 5407	with sealing 09 12 008 5408		

Han

thermoplastic / metal

Identification	Part number	Drawing	Dimensions in mm						
<b>Housings</b> Housings, bulkhead mounting Thermoplastic angled	<b>09 12 008 0902</b>	Pg 16							
Housings, bulkhead mounting Thermoplastic	<b>09 12 008 0327</b>	Pg 16							
Gasket for housings bulkhead mounting Han® Q 8/0	<b>09 12 000 9912</b>								
<b>Housings, surface mounting</b> Thermoplastic angled Cable gland order separately	<b>09 12 008 0901</b>	Pg 16							
<b>Hoods, cable to cable</b> Thermoplastic Cable gland order separately	<b>09 12 008 0727</b> <b>19 12 008 0729</b>	Pg 16 M 25	<table border="1" data-bbox="976 1966 1161 2056"> <tr> <td>h</td> <td>g</td> </tr> <tr> <td>13</td> <td>Pg 16</td> </tr> <tr> <td>14</td> <td>M 25x1.5</td> </tr> </table>	h	g	13	Pg 16	14	M 25x1.5
h	g								
13	Pg 16								
14	M 25x1.5								





Han

Insert	Size	Part No.		Drawing	Dimensions in mm															
		Male insert (M)	Female insert (F)																	
Order contacts separately				<p>1) Distance for contact max. 21 mm</p> <table border="1"> <thead> <tr> <th></th> <th>a</th> <th>b</th> </tr> </thead> <tbody> <tr> <td>24 DD</td> <td>44</td> <td>51</td> </tr> <tr> <td>42 DD</td> <td>57</td> <td>64</td> </tr> <tr> <td>72 DD</td> <td>77.5</td> <td>84.5</td> </tr> <tr> <td>108 DD</td> <td>104</td> <td>111</td> </tr> </tbody> </table>		a	b	24 DD	44	51	42 DD	57	64	72 DD	77.5	84.5	108 DD	104	111	
	a	b																		
24 DD	44	51																		
42 DD	57	64																		
72 DD	77.5	84.5																		
108 DD	104	111																		
Han <sup>®</sup> 24 DD	6 B	<b>09 16 024 3001</b>	<b>09 16 024 3101</b>																	
Han <sup>®</sup> 42 DD	10 B	<b>09 16 042 3001</b>	<b>09 16 042 3101</b>																	
Han <sup>®</sup> 72 DD	16 B	<b>09 16 072 3001</b>	<b>09 16 072 3101</b>																	
Han <sup>®</sup> 108 DD	24 B	<b>09 16 108 3001</b>	<b>09 16 108 3101</b>																	

Han DD <sup>®</sup> double contacts to connect the PCB-adapter	Part No.		Drawing	Dimensions in mm
	Male contacts	Female contacts		
	<b>09 15 000 6191</b>	<b>09 15 000 6291</b>		

Device side

PCB adapter for PCBs up to 1.6 mm for PCBs up to 2.4 mm	Part No.		Drawing	Dimensions in mm						
	<b>09 16 000 9905</b>	<b>09 16 000 9908</b>		<table border="1"> <thead> <tr> <th></th> <th>a</th> </tr> </thead> <tbody> <tr> <td><b>09 16 000 9905</b></td> <td>2.6</td> </tr> <tr> <td><b>09 16 000 9908</b></td> <td>3.4</td> </tr> </tbody> </table>		a	<b>09 16 000 9905</b>	2.6	<b>09 16 000 9908</b>	3.4
	a									
<b>09 16 000 9905</b>	2.6									
<b>09 16 000 9908</b>	3.4									

Housing	Size	Part No.		Drawing	Dimensions in mm																				
	6 B 10 B 16 B 24 B	<b>09 30 006 0301</b>	<b>09 30 010 0301</b> <b>09 30 016 0301</b> <b>09 30 024 0301</b>																						
				<table border="1"> <thead> <tr> <th>Size</th> <th>a</th> <th>b</th> <th>Panel cut out</th> </tr> </thead> <tbody> <tr> <td>6 B</td> <td>70</td> <td>80</td> <td>48 x 35</td> </tr> <tr> <td>10 B</td> <td>83</td> <td>93</td> <td>60 x 35</td> </tr> <tr> <td>16 B</td> <td>103</td> <td>113</td> <td>82 x 35</td> </tr> <tr> <td>24 B</td> <td>130</td> <td>140</td> <td>108 x 35</td> </tr> </tbody> </table>	Size	a	b	Panel cut out	6 B	70	80	48 x 35	10 B	83	93	60 x 35	16 B	103	113	82 x 35	24 B	130	140	108 x 35	Size 6 B with 1 locking lever
Size	a	b	Panel cut out																						
6 B	70	80	48 x 35																						
10 B	83	93	60 x 35																						
16 B	103	113	82 x 35																						
24 B	130	140	108 x 35																						

Cable side

Further informations see HARTING catalogue "Industrial Connectors Han<sup>®</sup>, chapter DD"

## Features

- ❑ Robust design
- ❑ Suitable for standard and EMC housing
- ❑ Low wiring costs
- ❑ Higher contact density

## Technical characteristics

### Approvals



### Inserts

Number of contacts 24, 42, 72, 108

Electrical data acc. to DIN VDE 0627

**7.5 A 250 V 4 kV 3**

Working current  
Working voltage  
Rated impulse voltage  
Pollution degree

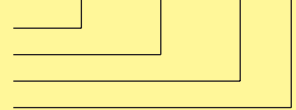

Working voltage acc. to UL

250 V

Testing voltage  $U_{rms}$   
Insulation resistance

2 kV  
 $\geq 10^{10} \Omega$

Material  
Limiting temperatures  
Flammability acc. to UL 94

Polyamide  
-40 °C / +125 °C  
HB

Mechanical working life

$\geq 500$

- Mating cycles  
Wire gauge

0.14 - 2.5 mm<sup>2</sup>

## Layout of printed circuit boards

Han<sup>®</sup> 24 DD

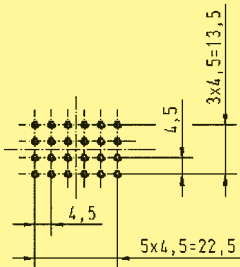

Han<sup>®</sup> 42 DD

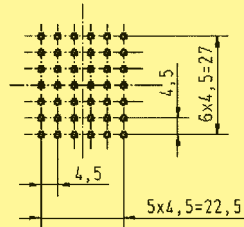

Han<sup>®</sup> 72 DD

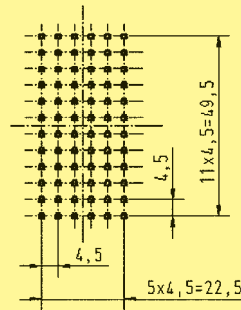

Han<sup>®</sup> 108 DD

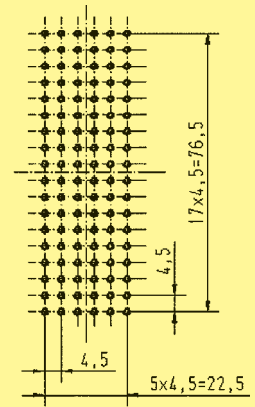

Recommended hole diameter: 0.8 mm

## Assembly situation

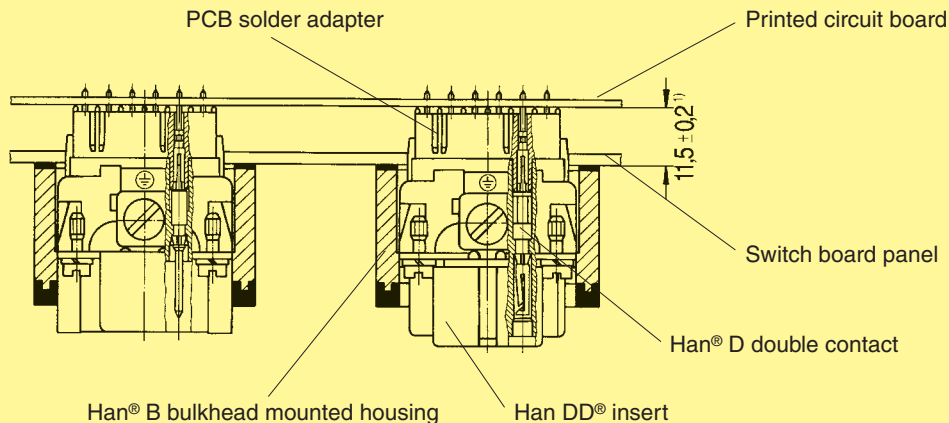

<sup>1)</sup> for Han<sup>®</sup> B EMC hoods/housings spacing of  $12.5 \pm 0.2$  is necessary as no flange seal is used.



## Features

- ❑ Robust design
- ❑ Suitable for standard and EMC housings
- ❑ Low wiring costs
- ❑ Counter connector available with screw, crimp or cage clamp termination

## Technical characteristics

### Inserts

Number of contacts 6, 10, 16, 24

Electrical data acc. to DIN EN 61 984

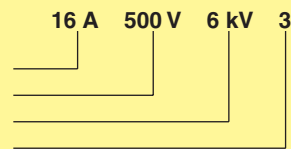

Working current  
Working voltage  
Rated impulse voltage  
Pollution degree

Insulation resistance  
Material  
Limiting temperatures  
Flammability acc. to UL 94  
Mechanical working life  
- Mating cycles  
Wire gauge

$\geq 10^{10} \Omega$   
Polycarbonate  
- 40 °C / +125 °C  
V 0  
 $\geq 500$   
0.5 - 4 mm<sup>2</sup>

## Layout of printed circuit boards

Han<sup>®</sup> 6 E

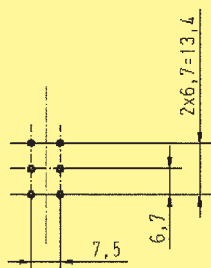

Han<sup>®</sup> 10 E

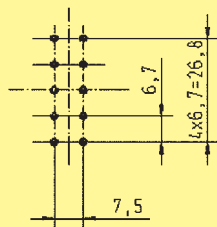

Han<sup>®</sup> 16 E

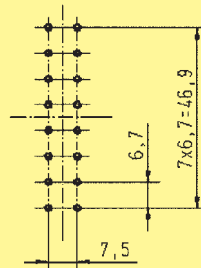

Han<sup>®</sup> 24 E

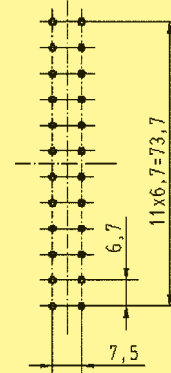

Recommended hole diameter: 1.8 mm

## Assembly situation

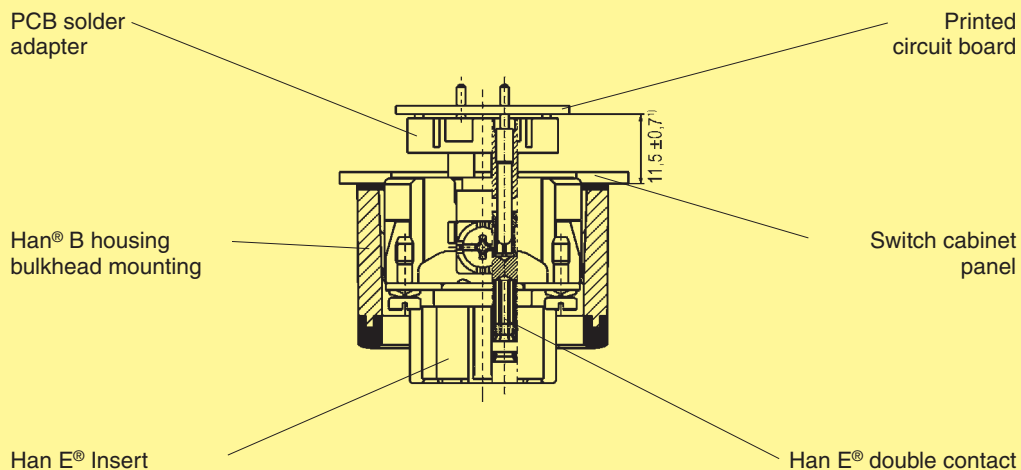

<sup>1)</sup> for Han<sup>®</sup> B EMC hoods/housings spacing of 12.5 ± 0.7 is necessary as no flange seal is used

Hinged frame	No. of modules	Part No.		Size	Figure
		Male insert (M)	Female insert (F)		
	1	<b>09 14 000 0304</b>	<b>09 14 000 0304</b>	10 A	Drawings and further details see HARTING catalogue "Industrial Connectors Han®, chapter 06".
	2	<b>09 14 006 0303</b>	<b>09 14 006 0313</b>	6 B	
	3	<b>09 14 010 0303</b>	<b>09 14 010 0313</b>	10 B	
	4	<b>09 14 016 0303</b>	<b>09 14 016 0313</b>	16 B	
	4	<b>09 14 016 0303</b>	<b>09 14 016 0313</b>	16 B	
	6	<b>09 14 024 0303</b>	<b>09 14 024 0313</b>	24 B	

Identification	Part No.		Drawing	Dimensions in mm						
	Male insert (M)	Female insert (F)								
<b>Han DD® module</b> PCB termination/ crimp termination	<b>09 14 012 3001</b>	<b>09 14 012 3101</b>								
<b>Han D® double contacts</b> to connect the PCB	<b>09 15 000 6191</b>	<b>09 15 000 6291</b>								
<b>PCB adapter</b> for PCBs up to 1.6 mm for PCBs up to 2.4 mm	<b>09 16 000 9905</b> <b>09 16 000 9908</b>			<table border="1"> <tr> <td></td> <td>a</td> </tr> <tr> <td><b>09 16 000 9905</b></td> <td>2.6</td> </tr> <tr> <td><b>09 16 000 9908</b></td> <td>3.4</td> </tr> </table>		a	<b>09 16 000 9905</b>	2.6	<b>09 16 000 9908</b>	3.4
	a									
<b>09 16 000 9905</b>	2.6									
<b>09 16 000 9908</b>	3.4									

Han® axial screw module	Part No.		Drawing	Dimensions in mm
	Male insert (M)	Female insert (F)		
<b>Axial screw termination</b> Cable side	<b>09 14 002 2601</b>	<b>09 14 002 2701</b>		
<b>PCB adaption</b> Device side	<b>09 14 002 2603</b>	<b>09 14 002 2703</b>		
<b>Solder contact</b>	<b>09 32 000 6295</b>			

Stock items in bold type



- Secondary mating between industrial connector and printed circuit board.
- No higher force is applied on the soldering joint when mating the industrial connector due to an additional mating point.
- No wiring between printed circuit board and industrial connector necessary.
- thus no wiring faults  
⇒ no testing, no costs
- Connecting times are minimized.
- Easy handling is time and cost saving.
- The production of mechanical and electrical / electronical components can be completely separated.
- Possibility to reach a higher degree of automation in the production (i. e. wave soldering of the PCBs).



Han DD® and Han® Q 5/0 PCB-adapter  
Wilhelm Fette GmbH, Germany



Han E® PCB-adapter

